

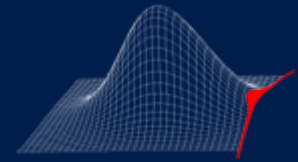

TECHNISCHE
UNIVERSITÄT
DRESDEN



Fakultät Maschinenwesen · Institut für Strömungsmechanik · Professur für Turbomaschinen und Strahlantriebe

Probabilistik im Turbomaschinenbau

Konrad Vogeler

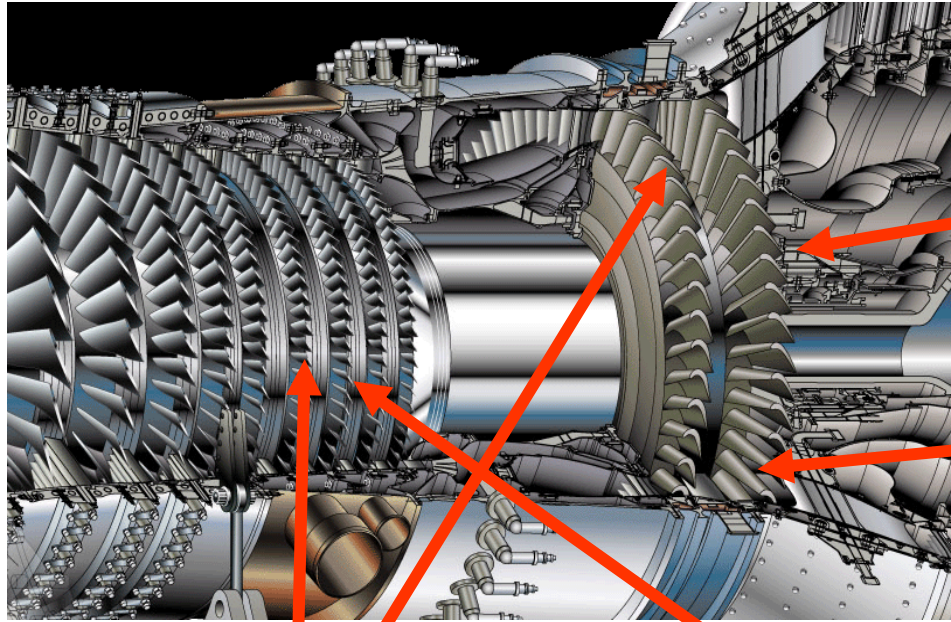
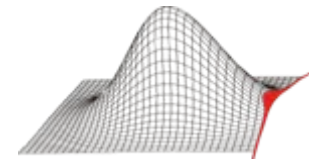

Robustes Design

Probabilistische Simulationen
eines Sekundärluftsystems
einer Gasturbine

Probabilistische Lebensdauer-
Untersuchungen von gekühlten
Turbinenschaufeln

Untersuchung des Einflusses von
Geometriestreuerungen auf den
Verdichterwirkungsgrad und auf
HCF Verhalten bei Verdichterschaufeln
(Produktion und Betrieb)

Aerodynamik und Kühlung

Aerodynamische Optimierung und
Verlustuntersuchungen für
Turbinen und Verdichter
Filmkühlung auf Seitenwänden

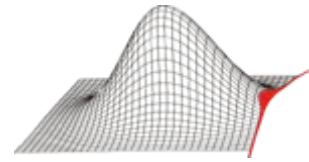

Zwei Turbinenschaufeln aus der gleichen Maschine



Quelle: Massachusetts Institute of Technology, Prof. David L. Darmofal

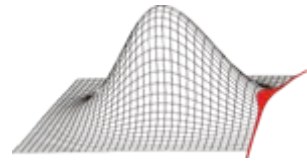

- Produktionsstreuungen (Geometrie)
- Produktionsstreuungen (Material)
- Randbedingungen (Temperatur, Drehzahl, Inzidenz...)

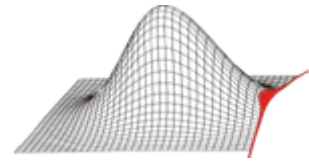

probabilistische Eingangsgrößen

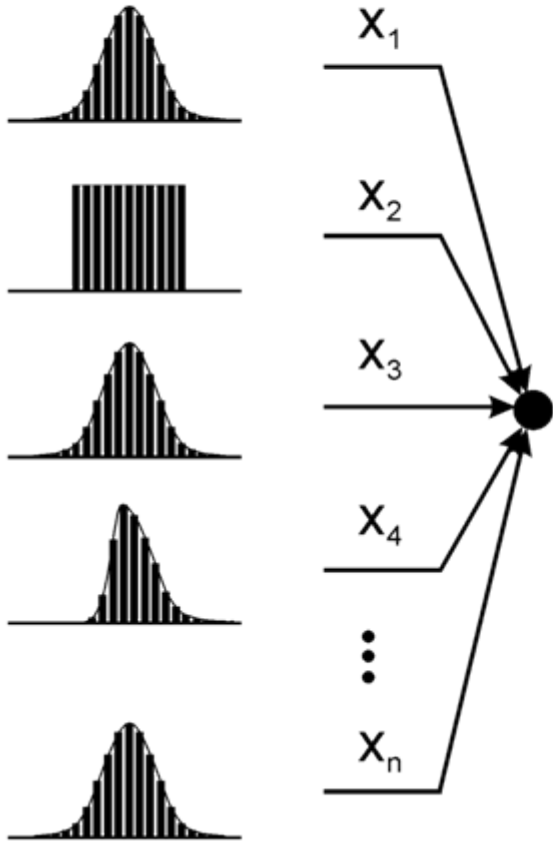

Strukturanalyse

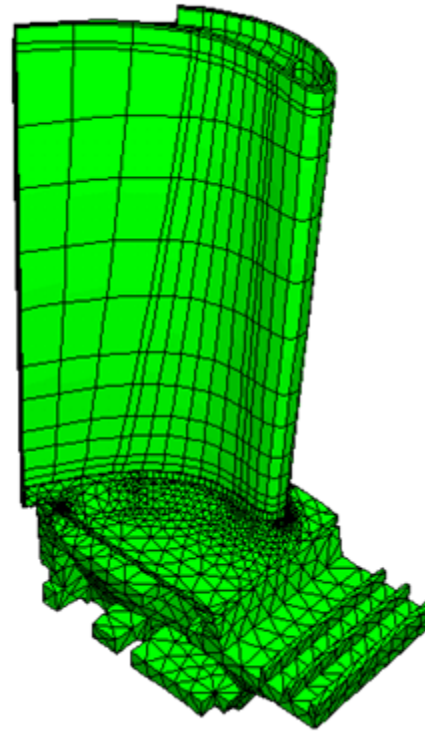

deterministisches
Modell

Streuung der Ergebnisgrößen

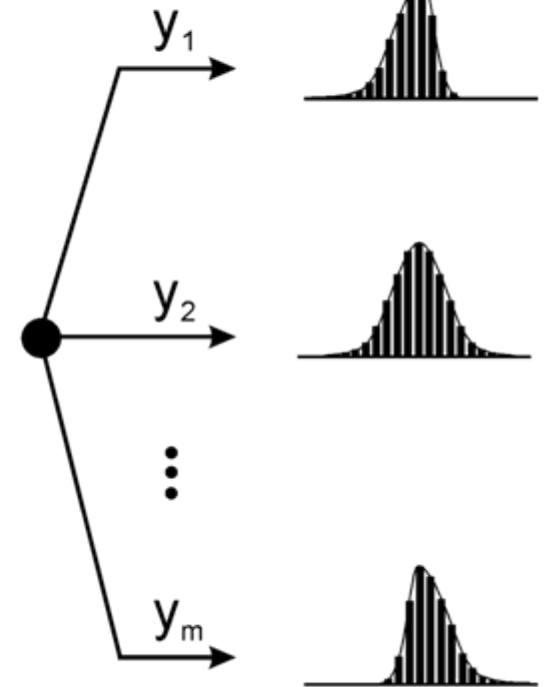

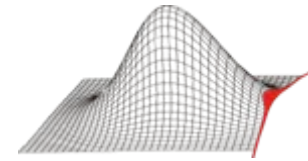

2D Mittelschnitt einer HPT Schaufel

1500 Elemente

3000 Knoten

ABAQUS (v6.3)

Mechanische Lasten wg. Rotation

Thermische Lasten wg. Temperaturdifferenzen (statisch)

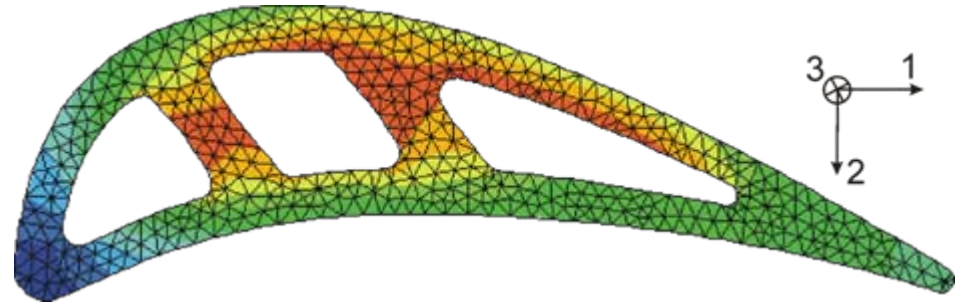

Input:

Kernbewegung beim Gießen, Young's Modulus, Wärmeleitfähigkeit, Ausdehnungskoeffizient, spez. Wärmekapazität, Materialdaten (LCF / creep), Zentrifugalkraft ...

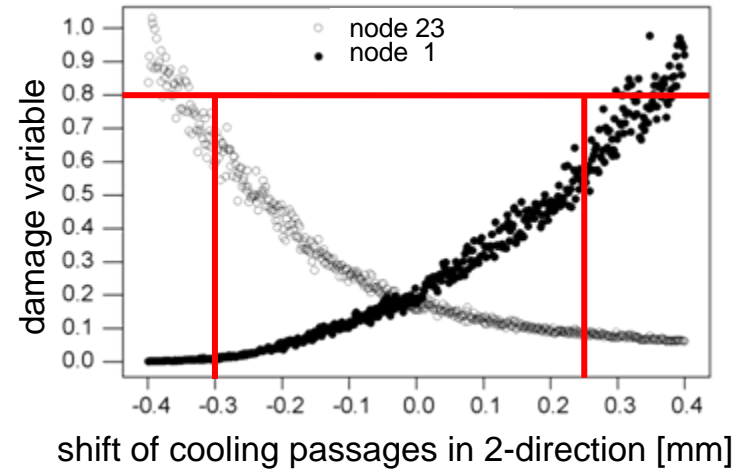
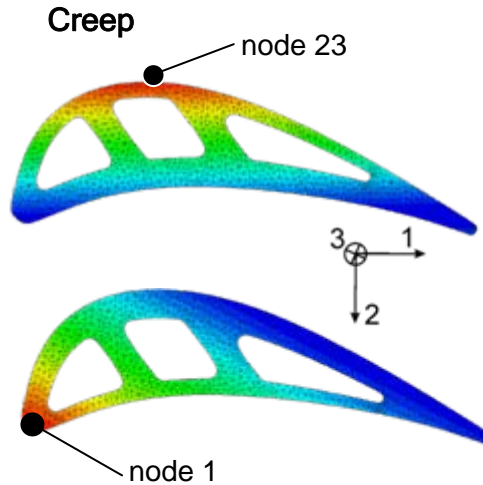
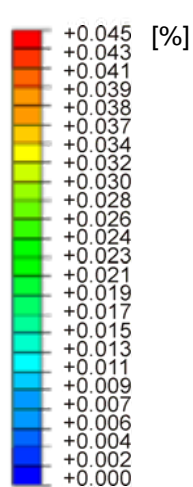
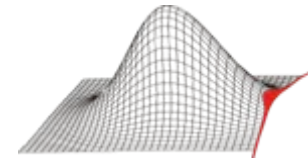

Damage variable

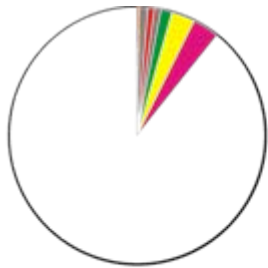

Cycle life number

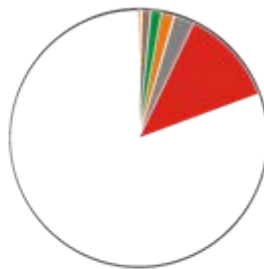

- base metal conductivity
- TMF material data
- specific heat capacity
- shift of cooling cores in direction 1

- coefficient of expansion
- Young's modulus
- centrifugal force
- shift of cooling cores in direction 2

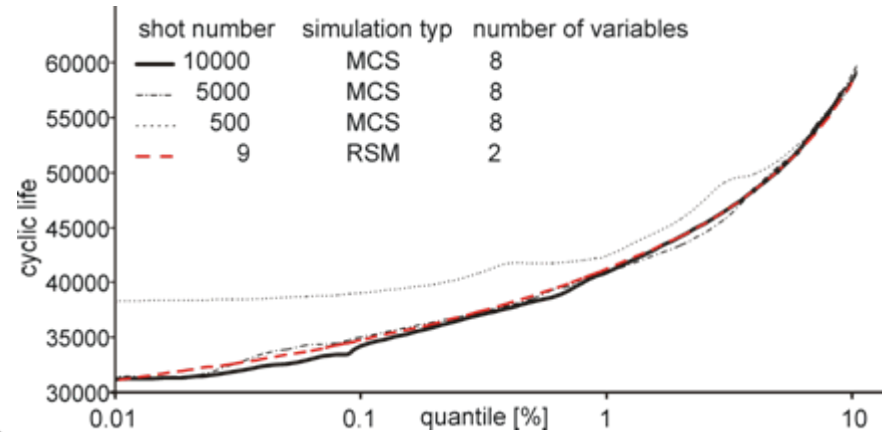

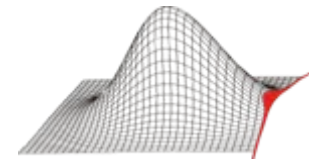

Ermitteln des Einflusses von Streuungen auf Durchflussraten und Leckagen des Sekundärluftsystems.

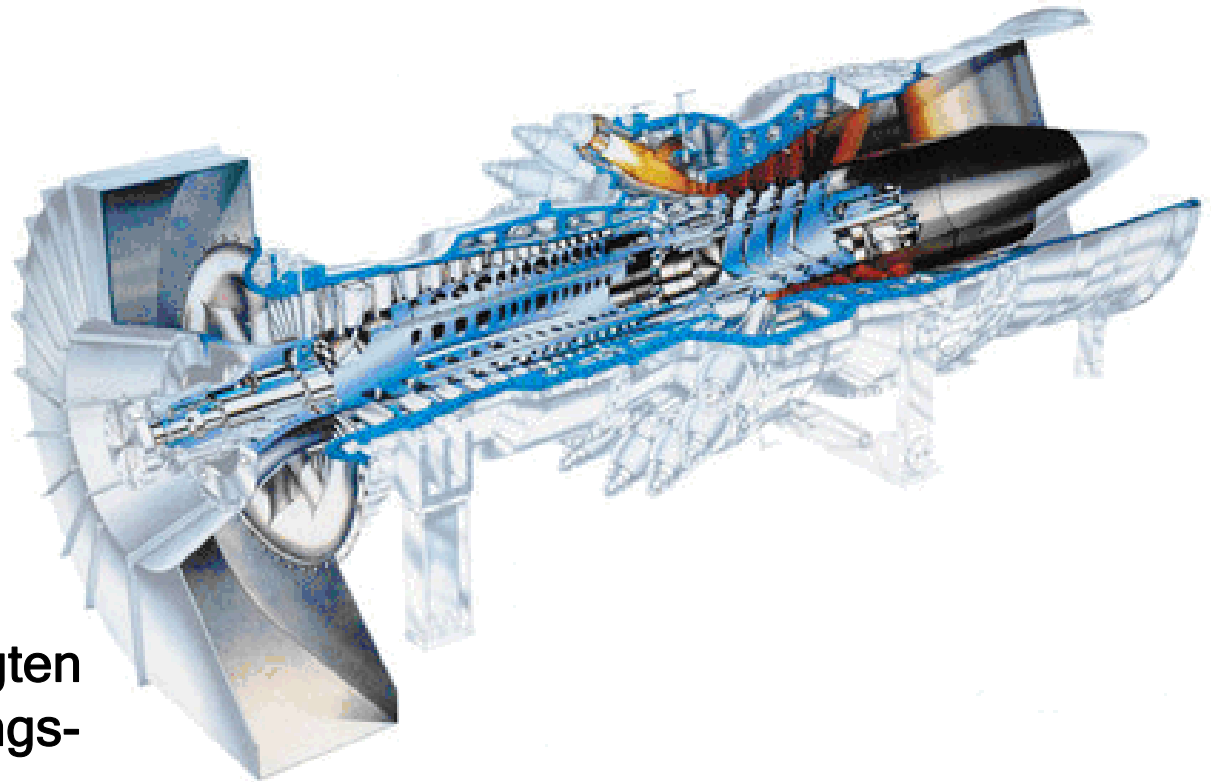

Anzahl der berücksichtigten probabilistischen Eingangsgrößen: bis zu 263

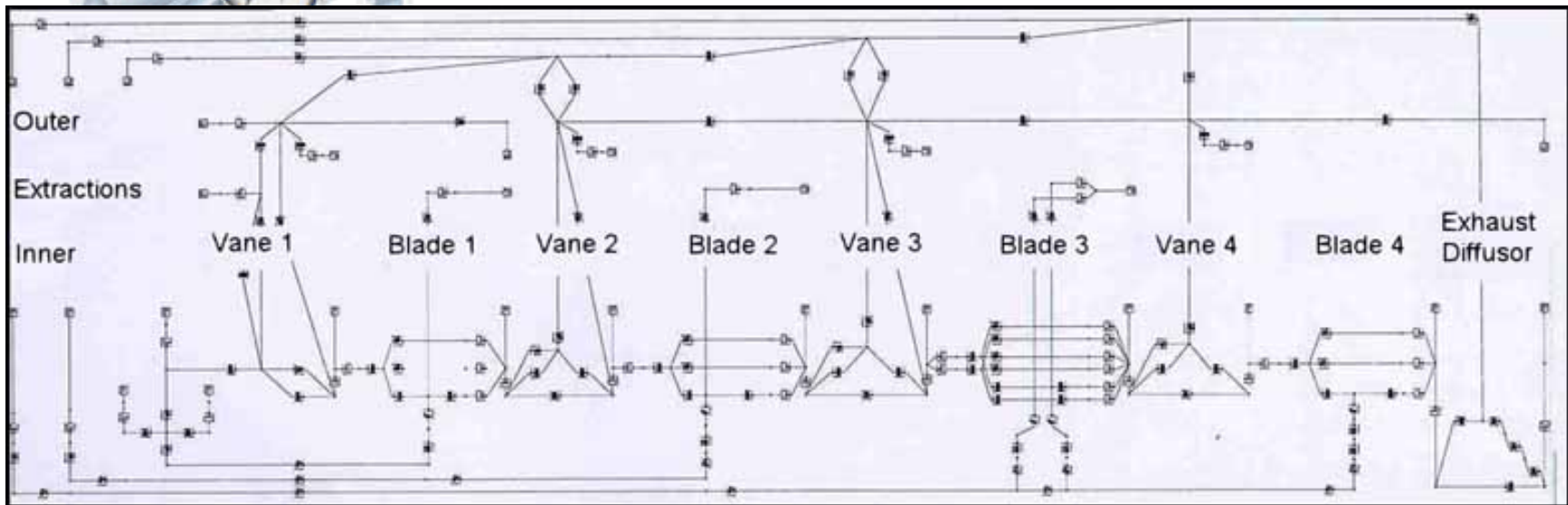
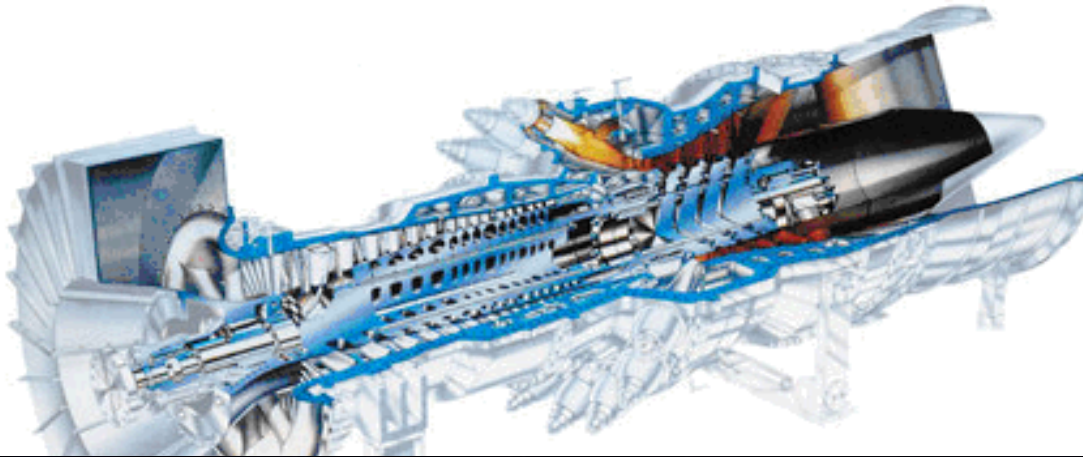
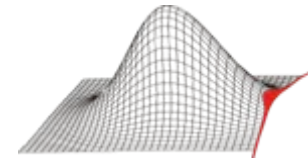

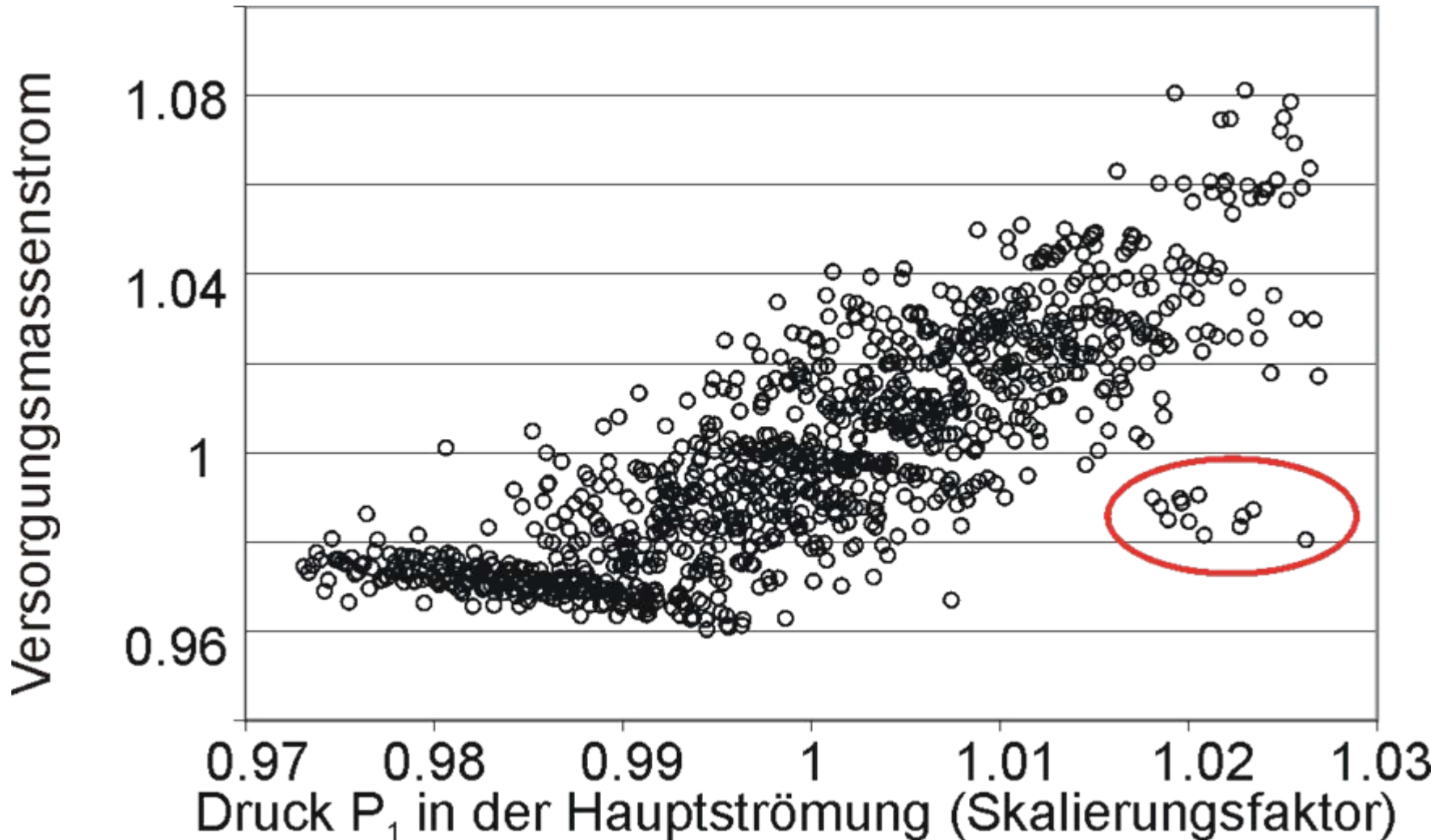
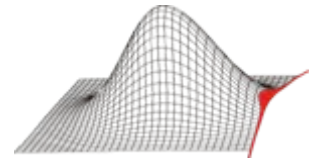

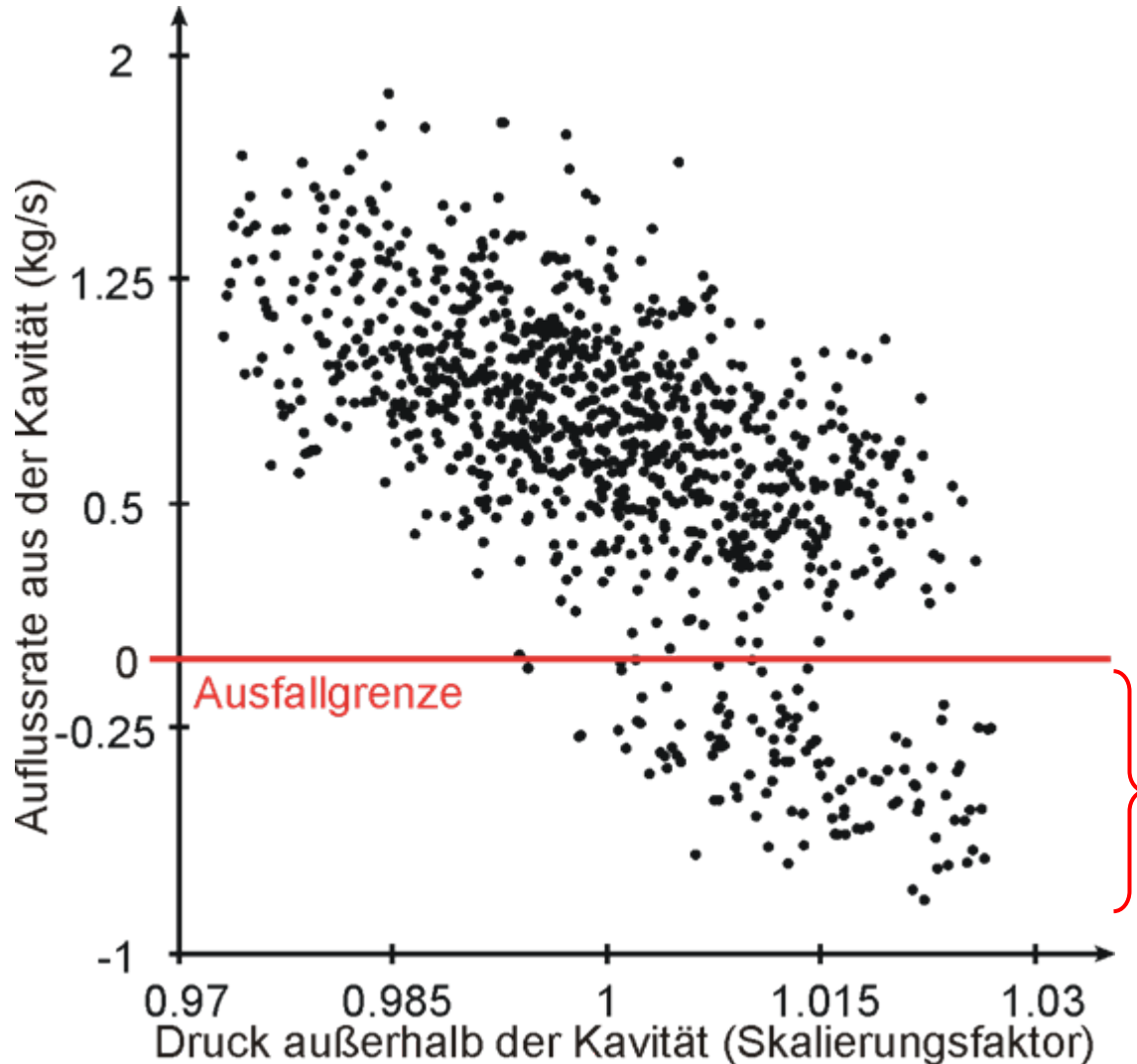
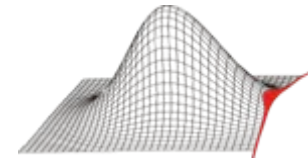

Heißgaseinbruch
→ Systemausfall

In diesem Beispiel:
 $P_f = 11.8\%$

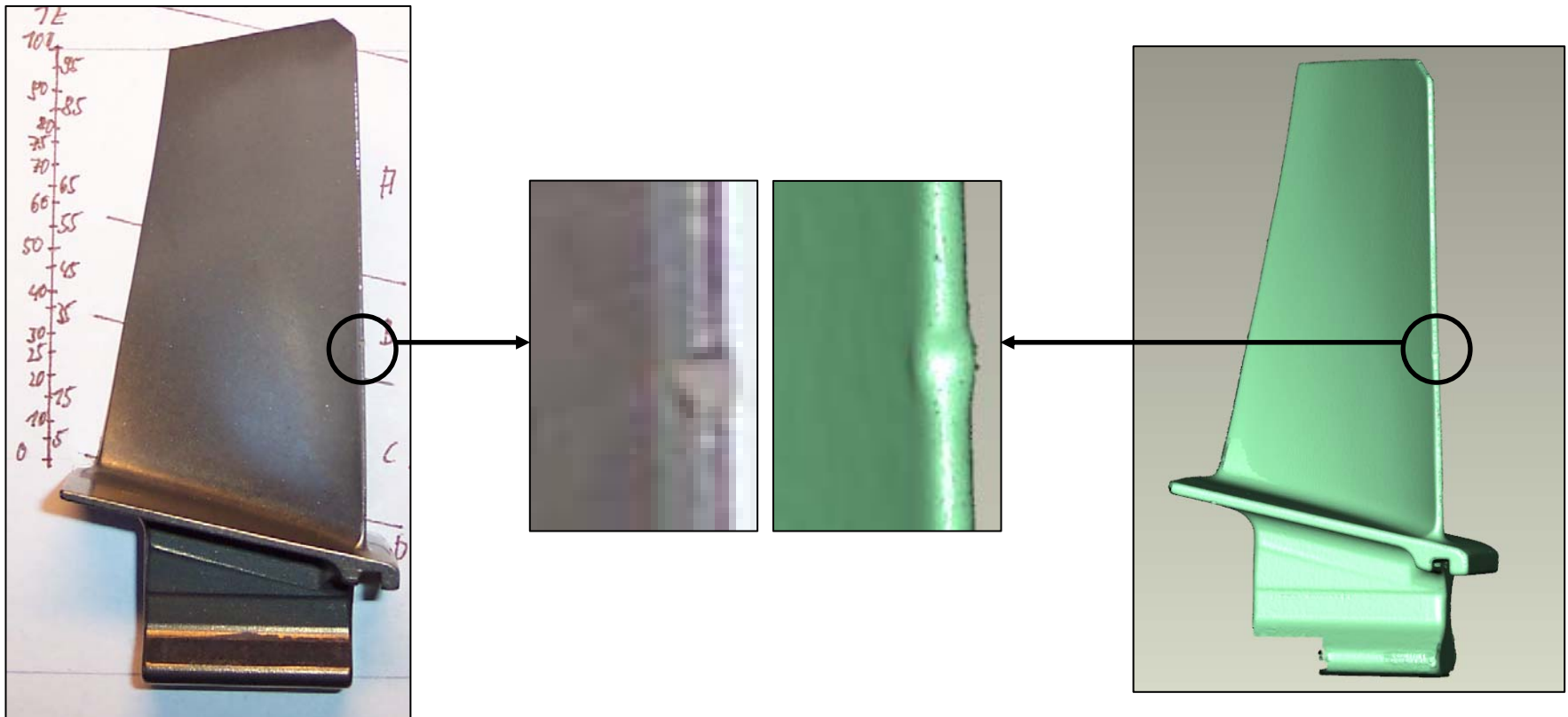
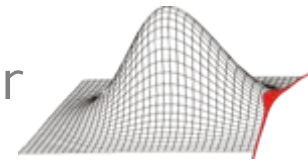

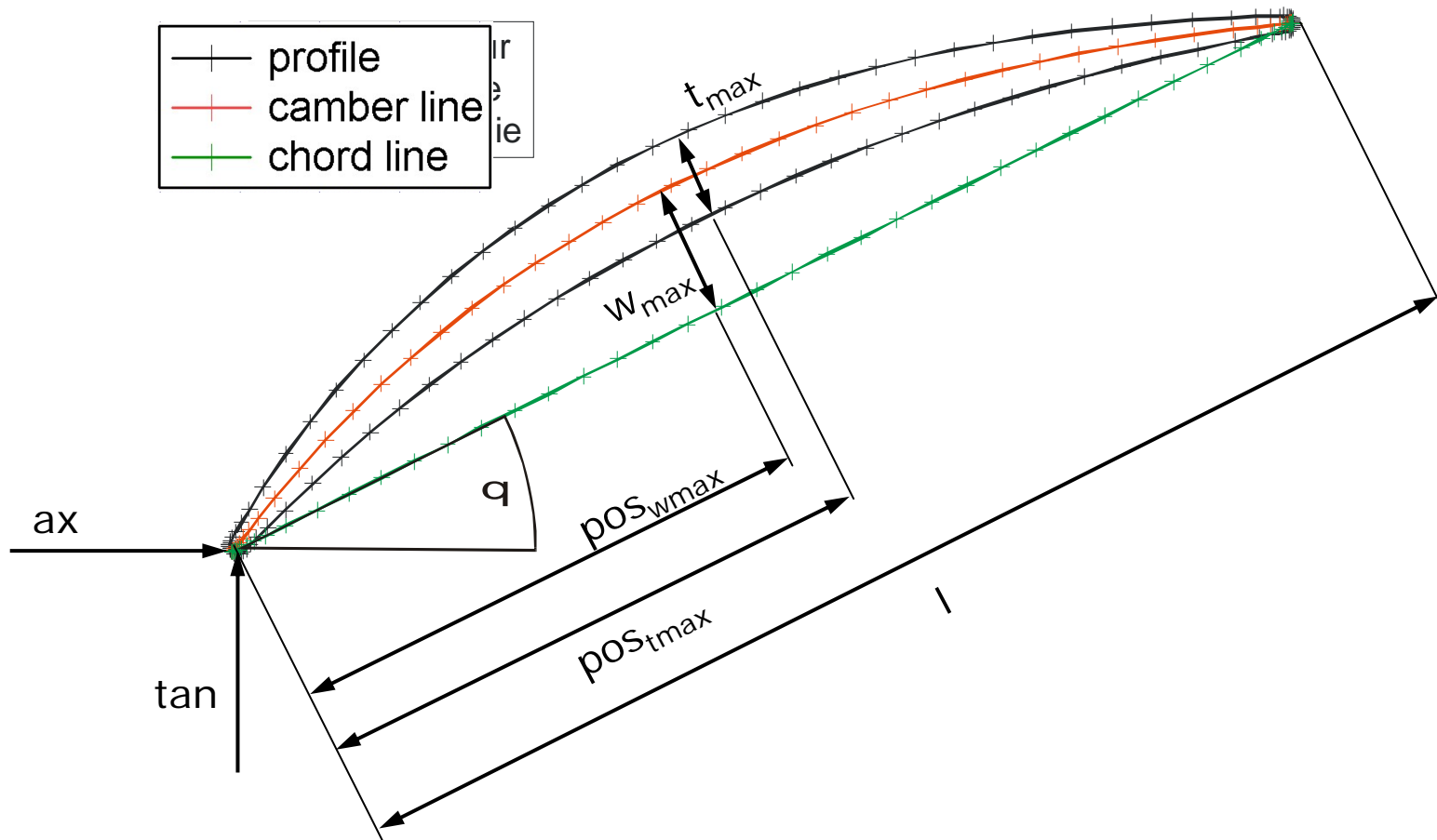
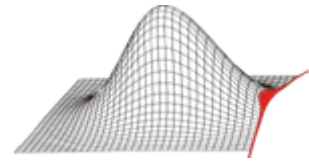

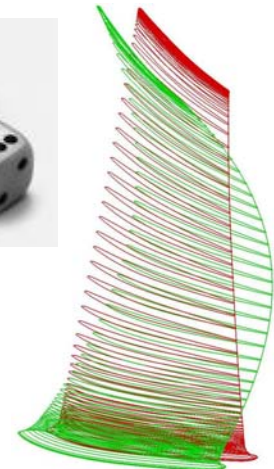
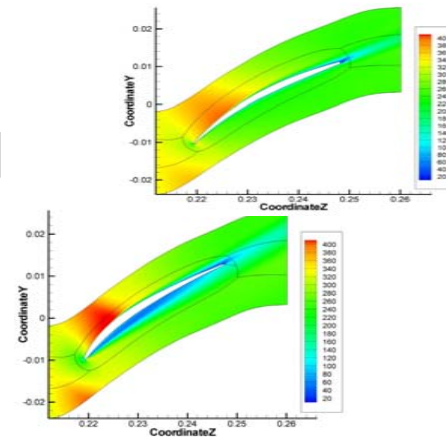
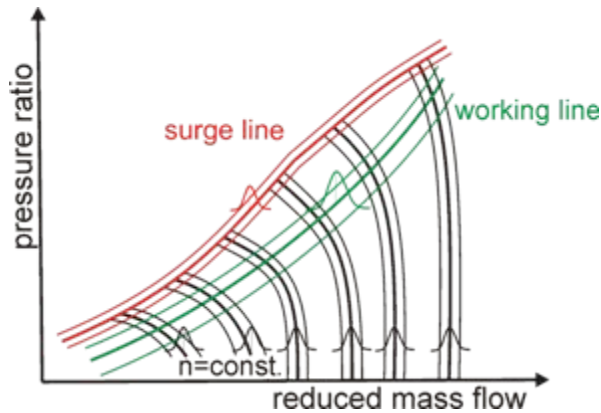
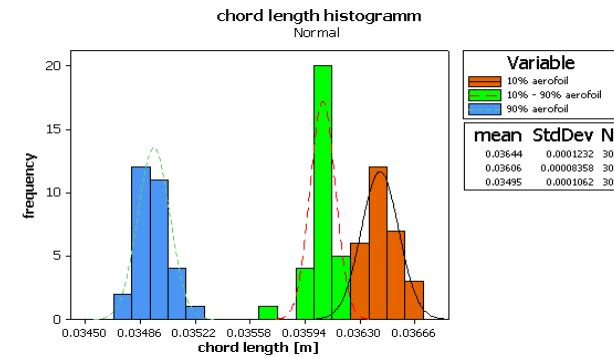
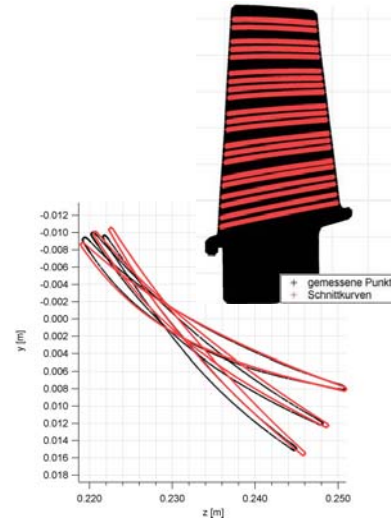
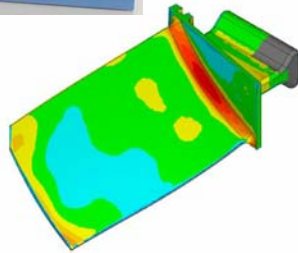
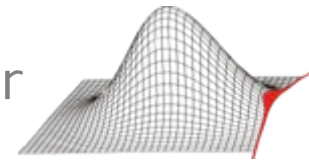

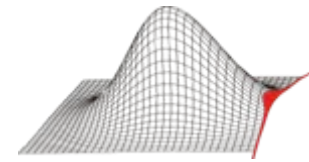

Ergebnis MCS: Einfluß der Parameter auf den Wirkungsgrad

Simulation 1:

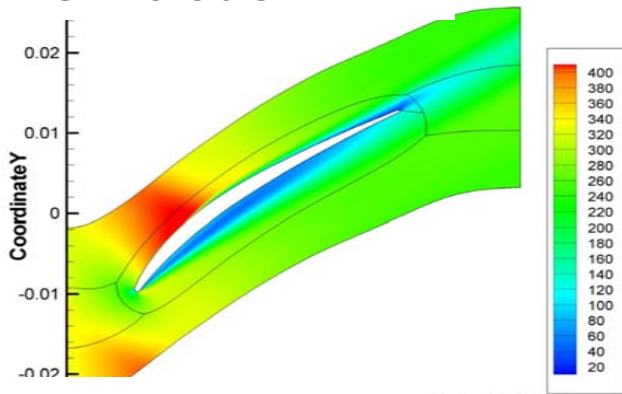

Simulation 2:

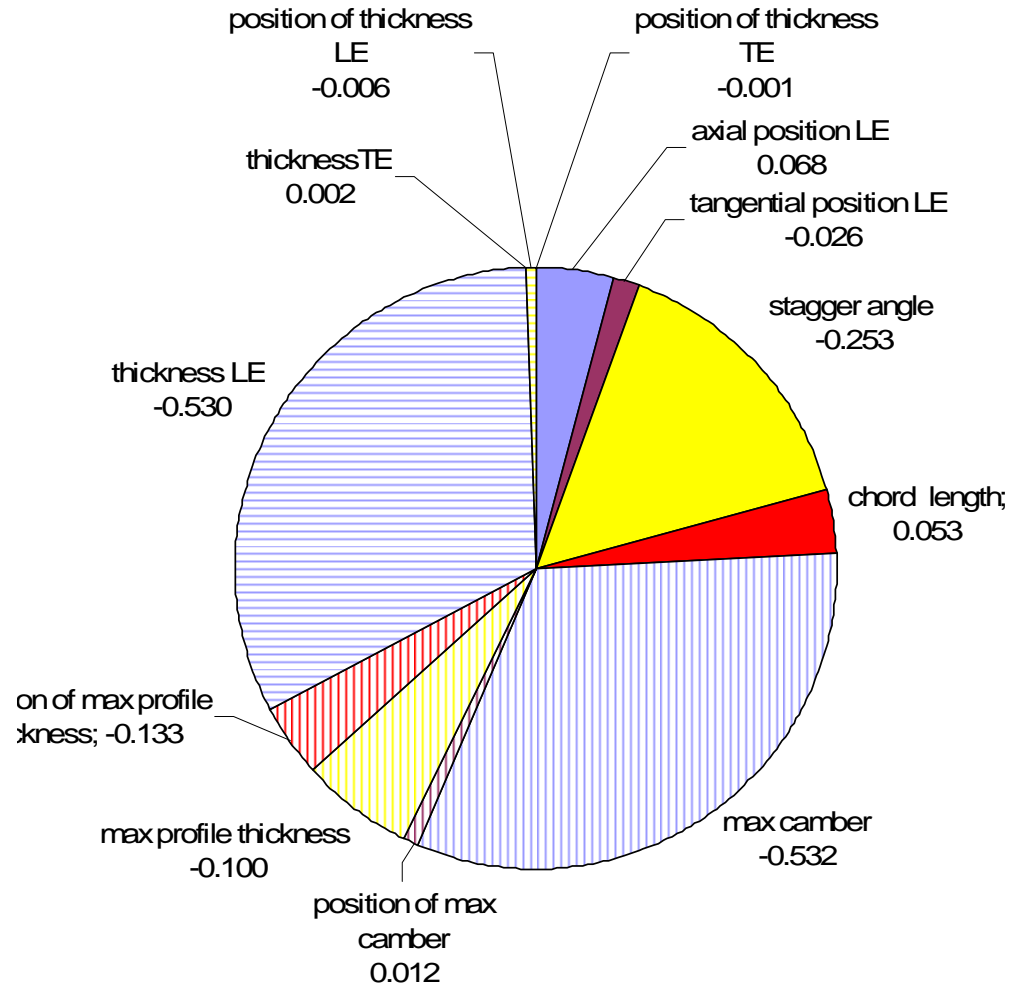
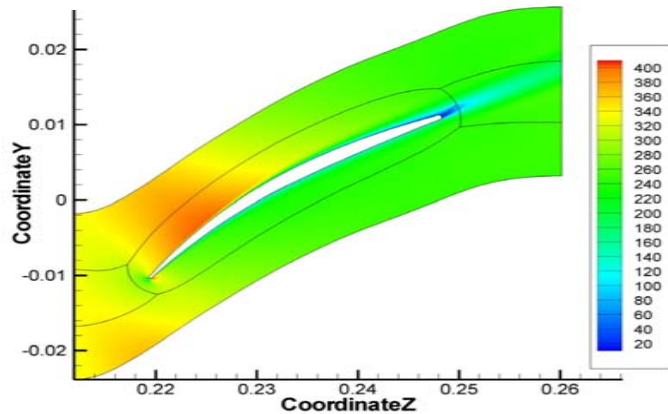

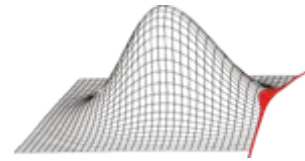

- Ausgang: Druckverteilung eines parametrisierten Verdichterprofils (NACA 6512)
- Ziel: Suchstrategie, um von einem beliebigen Ausgangsprofil das NACA 6512 wiederzufinden
- Ansatz: Zusätzliche Parameterisierung des CFD Netzes
- Abhängigkeit: Morphing mit Hypermesh in von den Profilparametern
- Suchstrategie: Korrelation zwischen der Druckverteilung und den Profilparametern

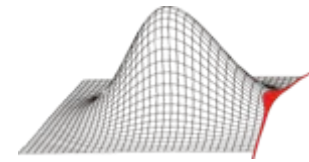

- Profilgenerator
- C-Programm mit Input:
- NACA 4-Digit Definition
NACA 6512
 - Wölbung (4-9)
 - Wölbungsrücklage (4-7)
 - Dicke (06-14)

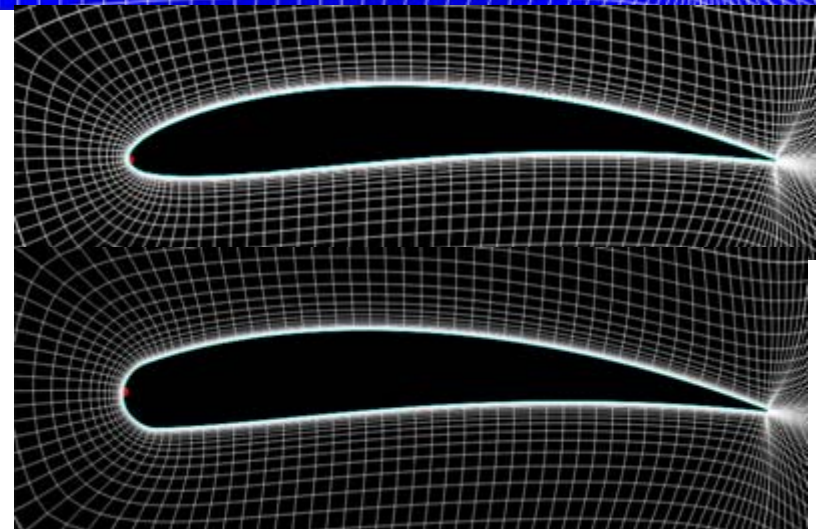
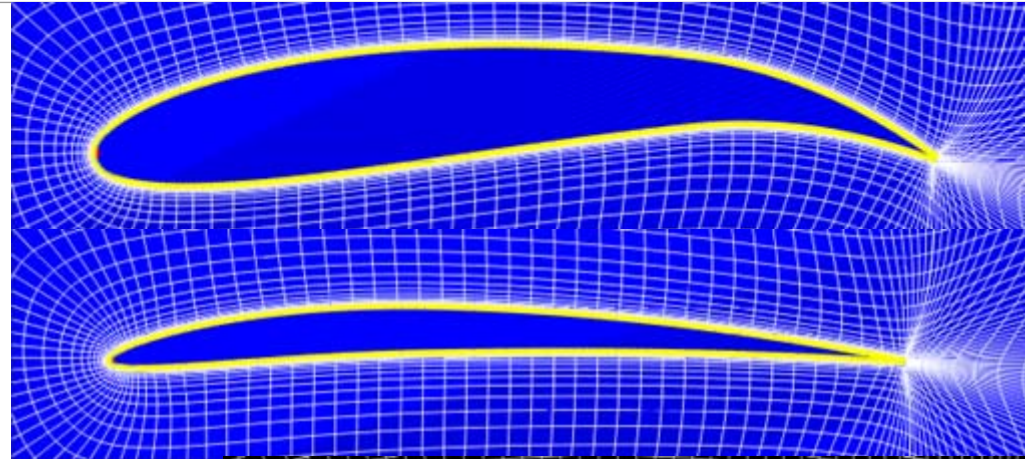

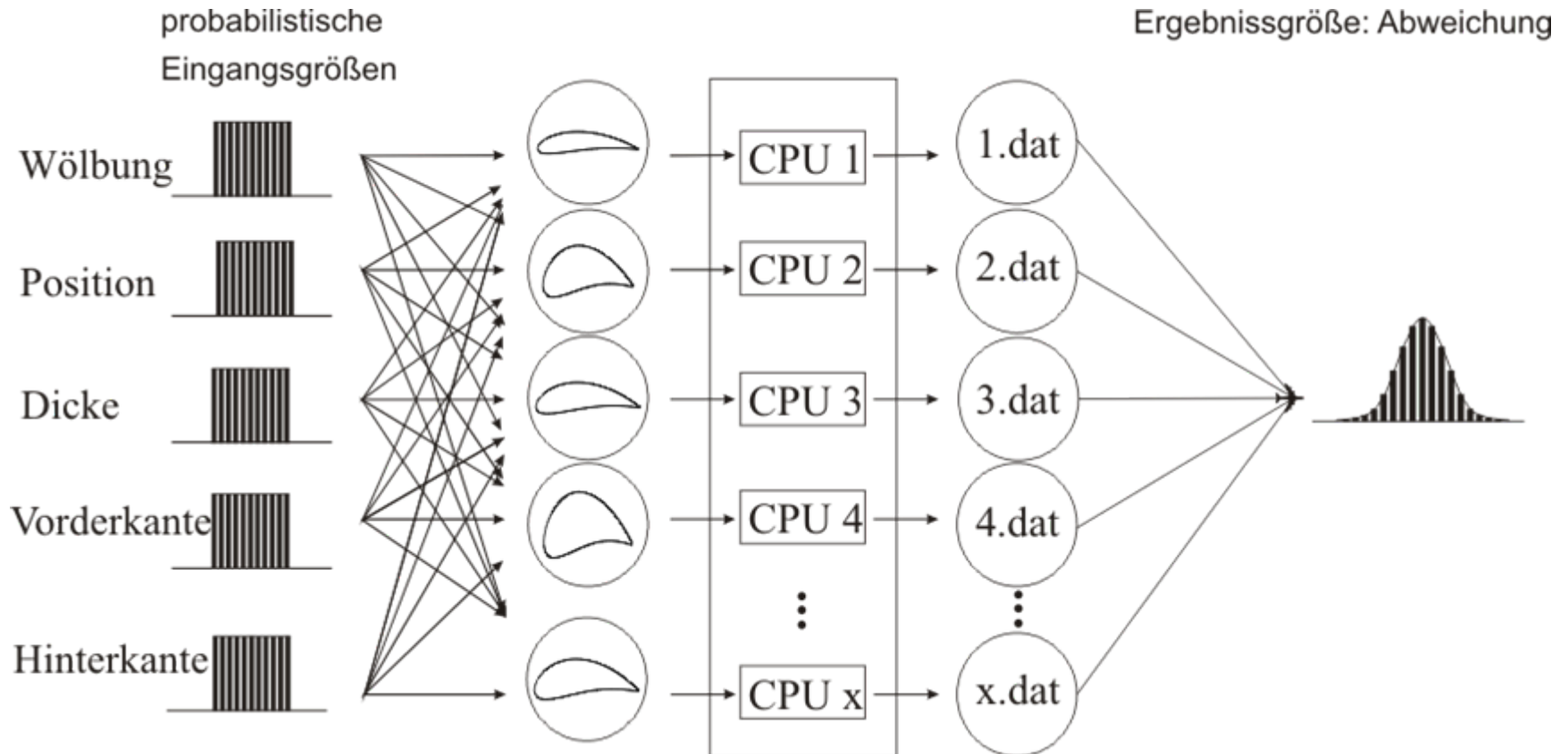
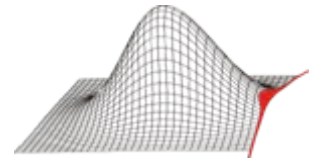

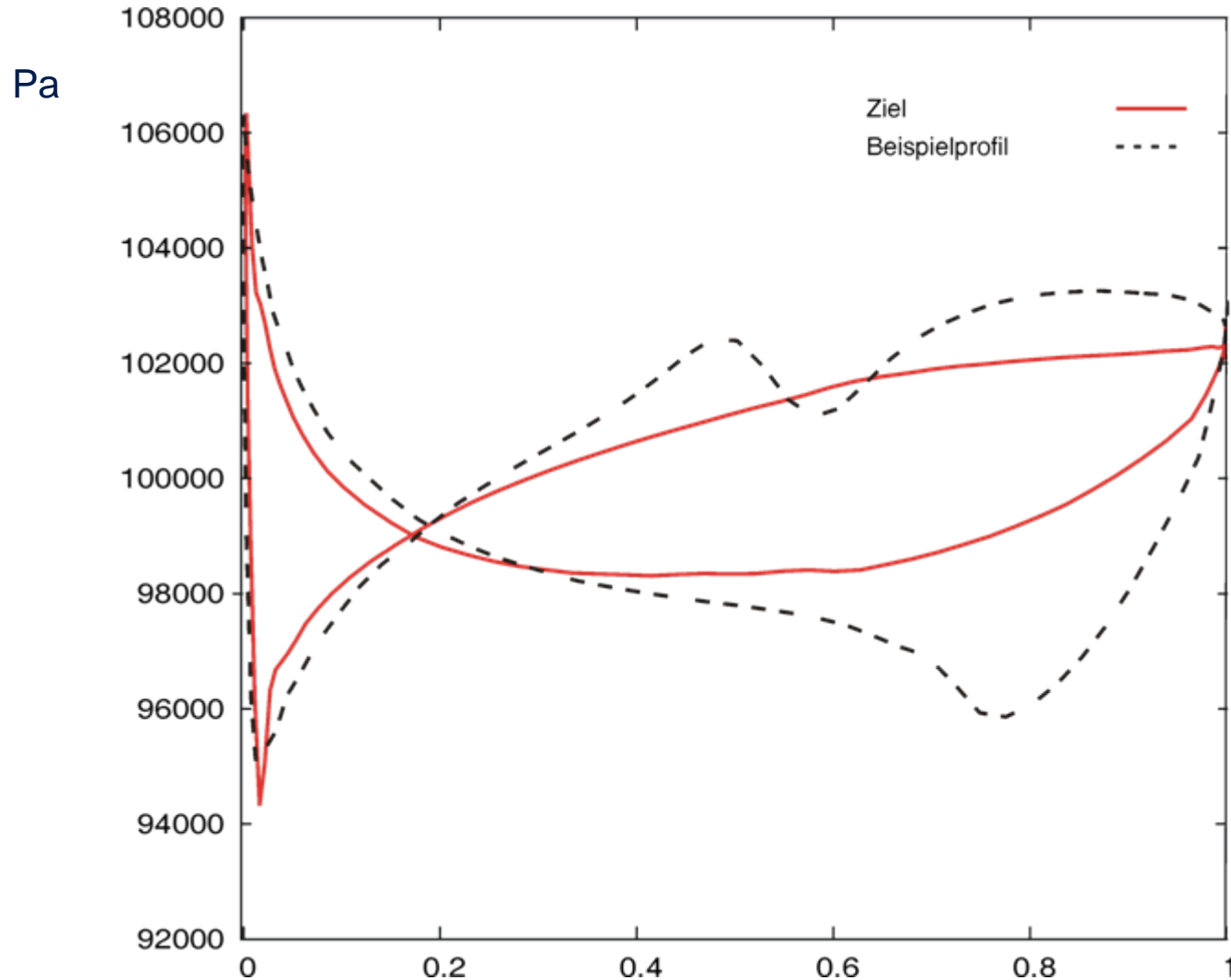
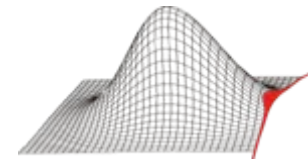

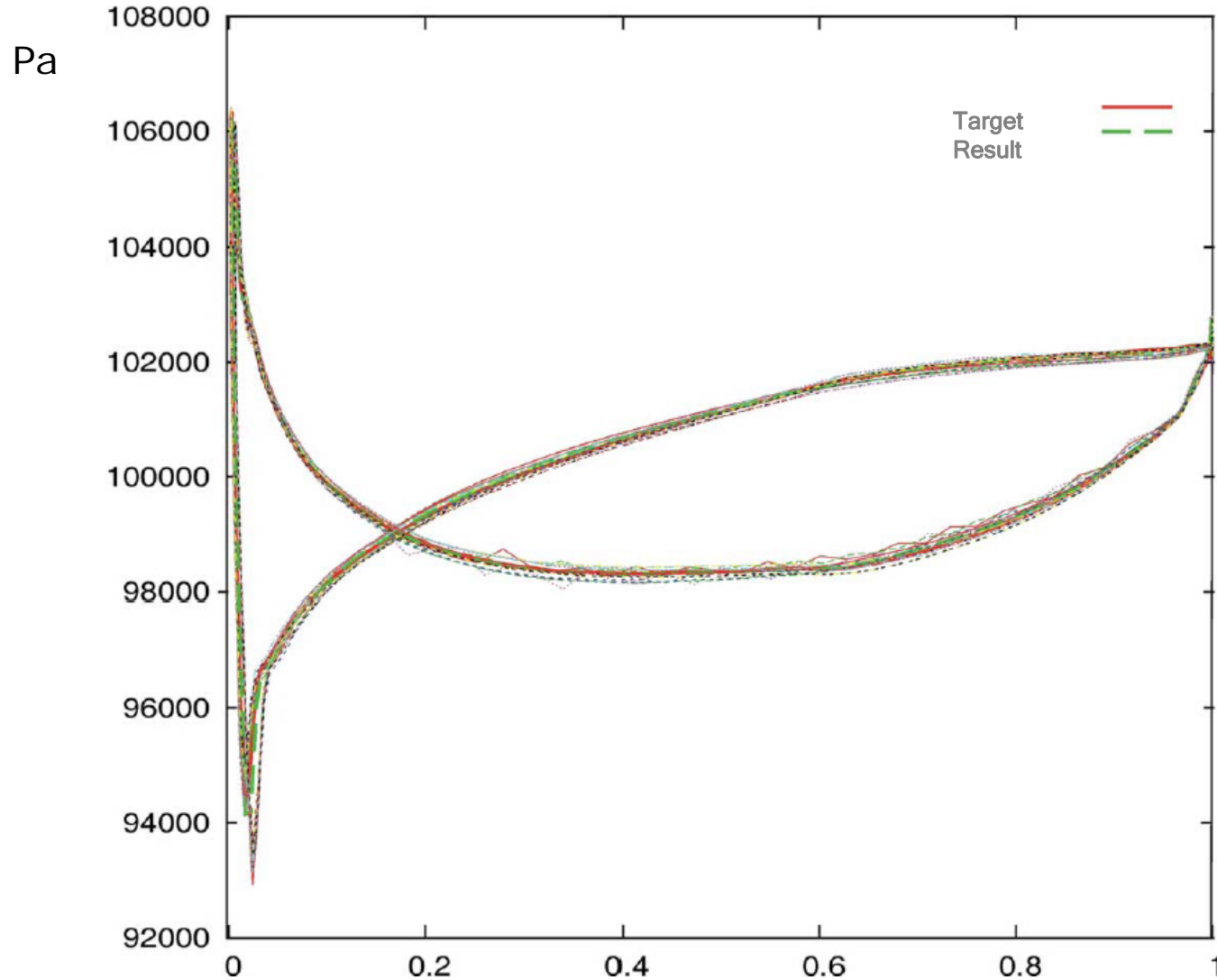
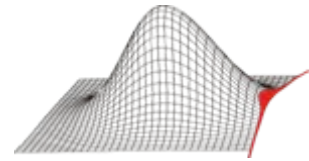

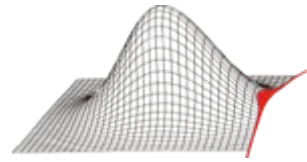

Kühlluftverteilung in kritischen Komponenten

Sekundärluftsystem mit gekühlten Komponenten

Einfluss der Fertigungstoleranzen auf Aerodynamik und Lebensdauer

Lebensdauer Rotorscheiben

Leistungsrechnung, wesentliche Einflußparameter

Verfügbarkeit; Einzelkomponente, Gesamtanlage

Wartungsstrategie / Ersatzteil Logistik

Evolutionäre Optimierung / Inverses Design

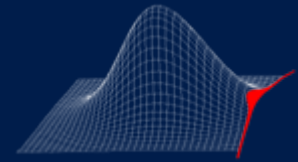

Probabilistik im Turbomaschinenbau

Konrad Vogeler

